

ROYCE CROSS GROUP

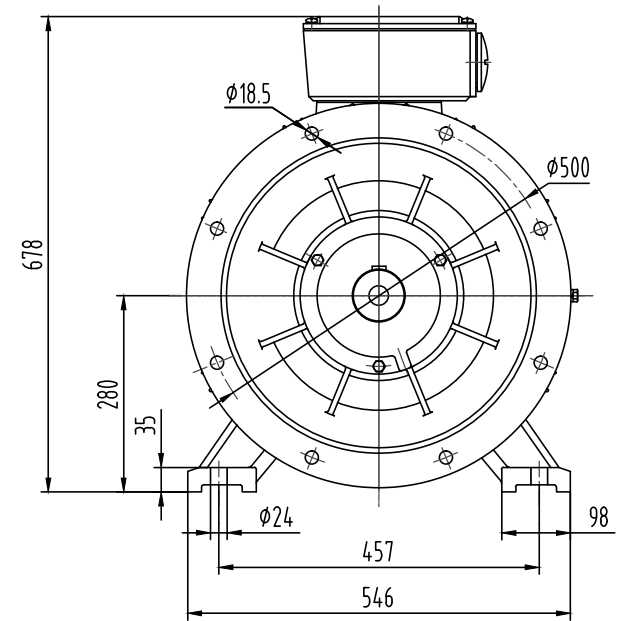
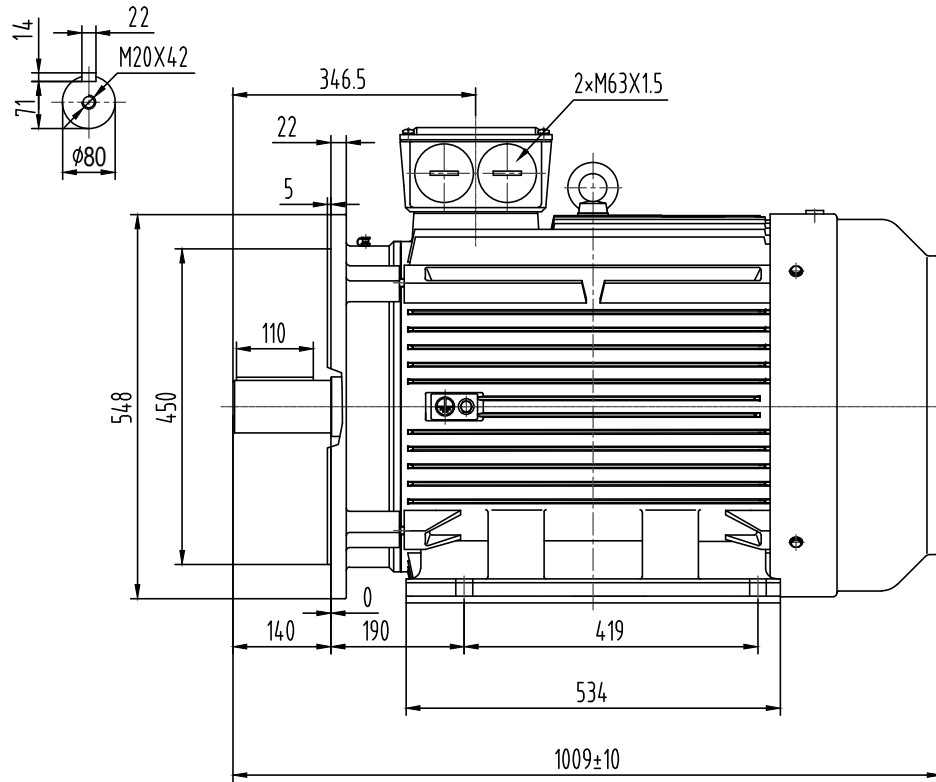

CUSTOMER APPROVAL _____
SIGNATURE DATE

**ROYCE
CROSS**
ELECTRICMOTORGROUP

YE2-280M-4.6.8(B35) DIMENSION OUTLINE	DATE		2013.1	CHK	
	DRAWN		zhang	APPD	
	ISSUE	A	DATE	CERTIFIED BY	
	ISSUE	B	DATE	CERTIFIED BY	
	ISSUE	C	DATE	CERTIFIED BY	
	ISSUE	D	DATE	CERTIFIED BY	