

ROYCE CROSS GROUP

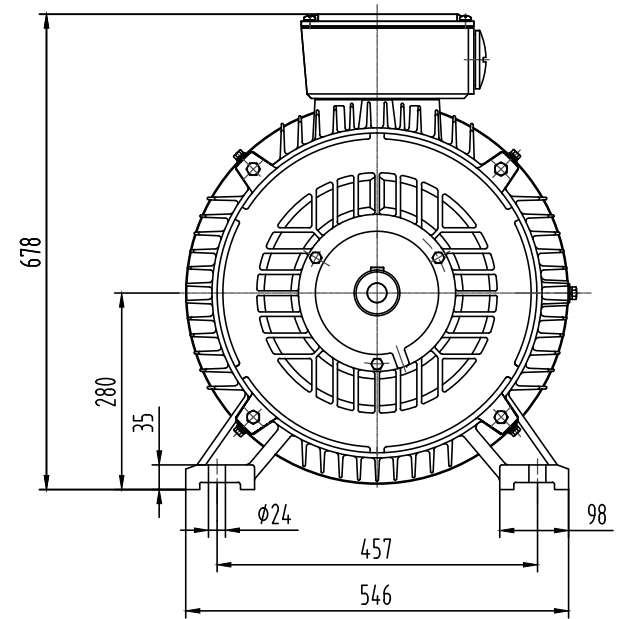

CUSTOMER APPROVAL _____
SIGNATURE DATE

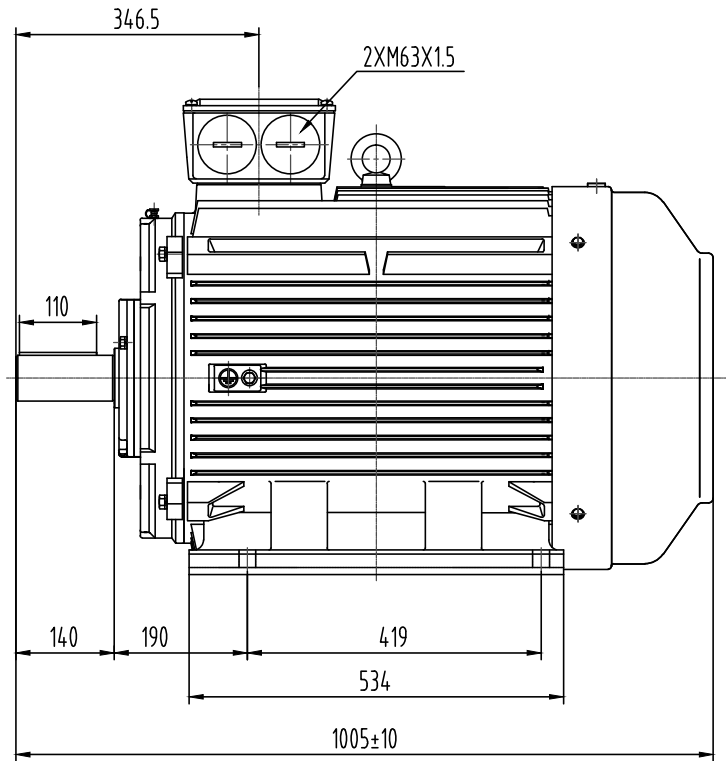
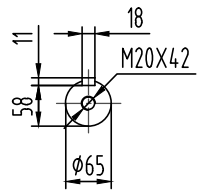

YE2-280M-2(B3) DIMENSION OUTLINE	DATE		2013.1	CHK	
	DRAWN		zhang	APPD	
	ISSUE	A	DATE		CERTIFIED BY
	ISSUE	B	DATE		CERTIFIED BY
	ISSUE	C	DATE		CERTIFIED BY
	ISSUE	D	DATE		CERTIFIED BY